

Marine Sources

HIGH-PERFORMANCE IMPULSIVE SOURCES

HIGH-PERFORMANCE IMPULSIVE SOURCES



Sercel has 30 years of experience in the design and manufacture of marine sources. Throughout this time, Sercel has developed sources for all applications encountered within the seismic industry, including the most demanding environments.

This expertise has provided us with the foundations for designing a turnkey marine seismic source solution that can be adapted to every customer's need and operating environment as well as be built on for future source solutions and other in-sea equipment such as float systems.

The design philosophy driving all our marine source products is ease-of-use, safety and reliability. Sercel offers the most comprehensive air impulsive source portfolio in the industry that can be used for seismic & engineering applications such as towed streamer, shallow water/OBC/OBN and VSP surveys.

COMPLETE PACKAGE

G-SOURCE II



Streamer



Shallow Water

MINI G-SOURCE & GI-SOURCE



G-SOURCE



Borehole

STREAMER

G-SOURCE II



+5% 0-Peak Output compared to conventional impulsive sources



Designed to operate continuously at up to 3,000 psi (210 bars)



High degree of pulse repeatability



Recoilless



Possibility to deploy impulsive sources at sea without pressure



The G-SOURCE II is the safest, easiest-to-use and most reliable impulsive source in the industry. It offers a lightweight, compact solution for consistent performance and flexibility thanks to its advanced Volume Reducer technology.

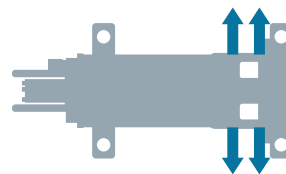

Phase 1

A special patented design allows the compressed air that is released to be deflected at the sides, resulting in recoilless shooting.

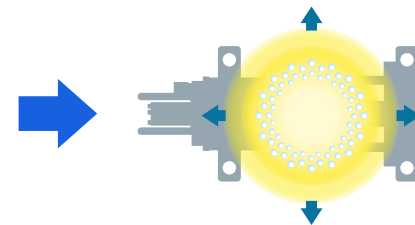

Phase 2

High-pressure air explosively released into the surrounding water generates the main acoustic pulse.

Specifications



	G-SOURCE II 150	G-SOURCE II 250	G-SOURCE II 380	G-SOURCE II 520
Available volume (cu.in)	45 · 50 · 60 · 70 · 80 · 90 · 100 · 110 · 120 · 130 · 140 · 150	180 · 200 · 210 · 220 · 250	320 · 340 · 350 · 360 · 380	520
Length	L = 597mm	L = 597mm	L = 640mm	L = 640mm
Width	W = 292mm	W = 292mm	W = 292mm	W = 292mm
Weight	55kg	65kg	85kg	90kg

Single impulsive source type

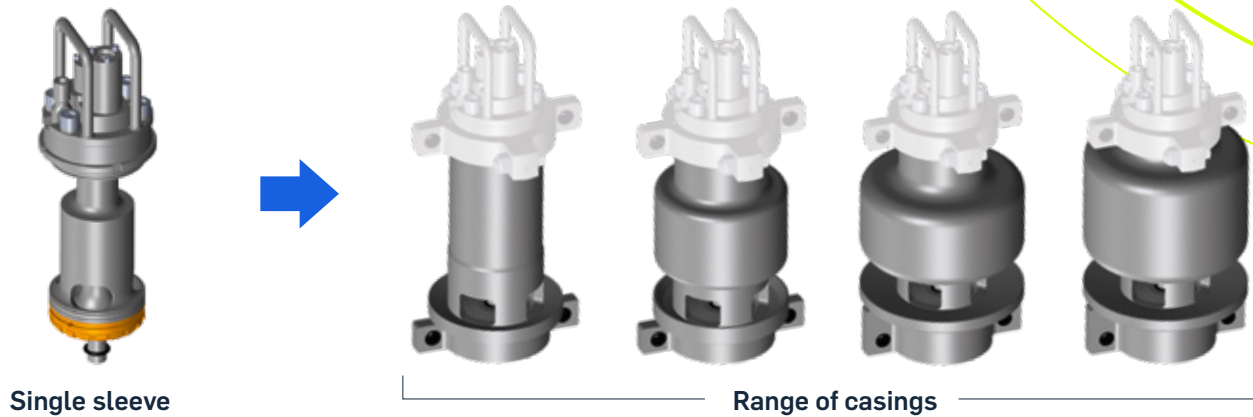

Each impulsive source volume can be easily changed by means of inexpensive "Volume Reducers" or by changing the external casing.

- Single set of spare parts for the entire G-SOURCE II range.
- Assemble/disassemble within minutes without special tooling.
- Firing/sensor/sleeve/shuttle system for all G-SOURCE II.

With its mechanical advantages and strong acoustic performance the G-SOURCE II is the impulsive source of choice for high-production seismic vessels.

For maximum energy output and high signature consistency shot after shot, G-SOURCE II impulsive sources can be configured in impulsive source clustered elements using our patented parallel cluster assembly design.

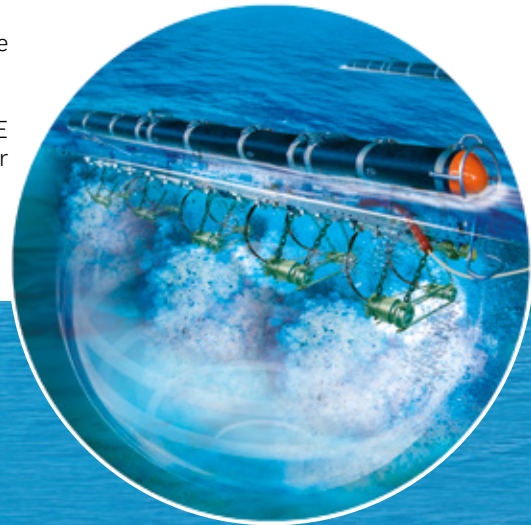

SHALLOW WATER

GI-SOURCE



Clean acoustic signature



Light and compact



Flexible configuration



Sercel developed the GI-SOURCE to reduce and suppress the bubble oscillation from a single impulsive source to simplify processing. The GI-SOURCE impulsive source is based on the same technology as the G-SOURCE but is different in that it has two independent air chambers within the same casing.

- The Generator, generating the primary pulse and creating the main bubble.
- The Injector, injecting air inside the main bubble so that it collapses quickly.

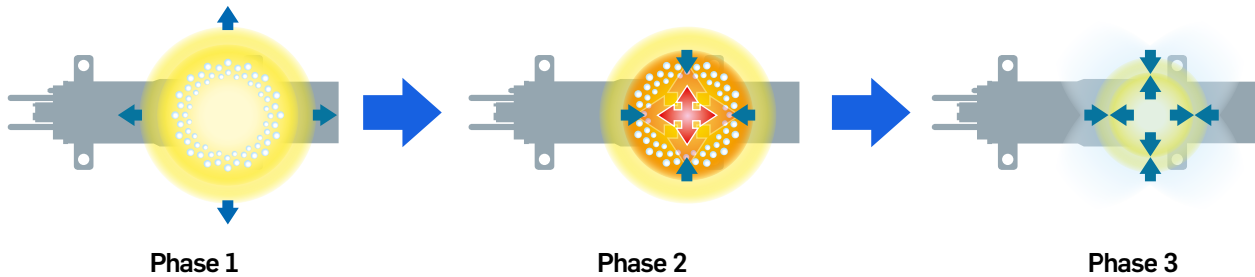

Phase 1
The Generator is fired. The blast of compressed air produces the primary pulse and the bubble starts to expand.

Phase 2
Just before the bubble reaches its maximum size, the injector is fired, injecting air directly inside the bubble.

Phase 3
The volume of air released by the injector increases the internal pressure of the bubble and prevents its violent collapse. The oscillations of the bubble and the resulting secondary pressure pulses are reduced and reshaped.

Specifications



	GI-SOURCE 210	GI-SOURCE 255	GI-SOURCE 355
Volume	210cu.in (G = 105cu.in I = 105cu.in)	255cu.in (G = 150cu.in I = 105cu.in)	355cu.in (G = 250cu.in I = 105cu.in)
Length	L = 790mm	L = 860mm	L = 860mm
Width	W = 312mm	W = 280mm	W = 280mm
Weight	74kg	87kg	97kg

Clean acoustic signature

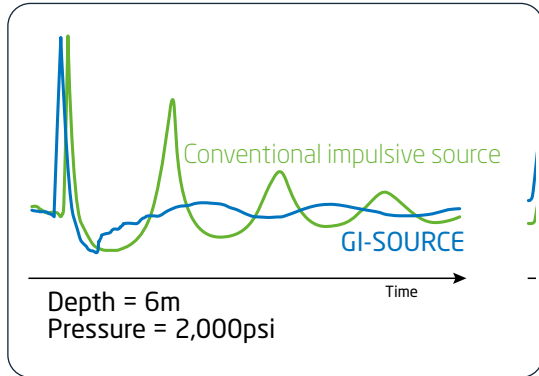

Near-field signatures

Compared to a conventional impulsive source, the peak-to-peak is reduced due to the volume of the Generator but the primary-to-bubble ratio is greatly increased resulting in a clean acoustic signature.

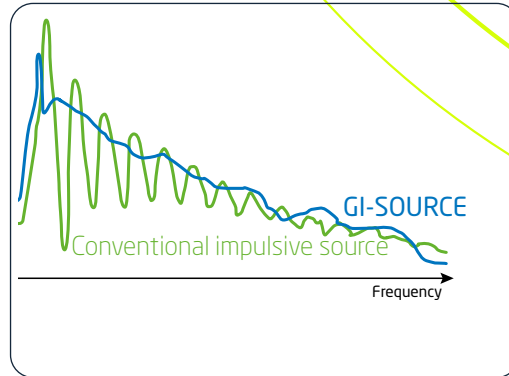

Near-field amplitude spectra

The "true GI mode" results in an almost total suppression of the bubble oscillation.

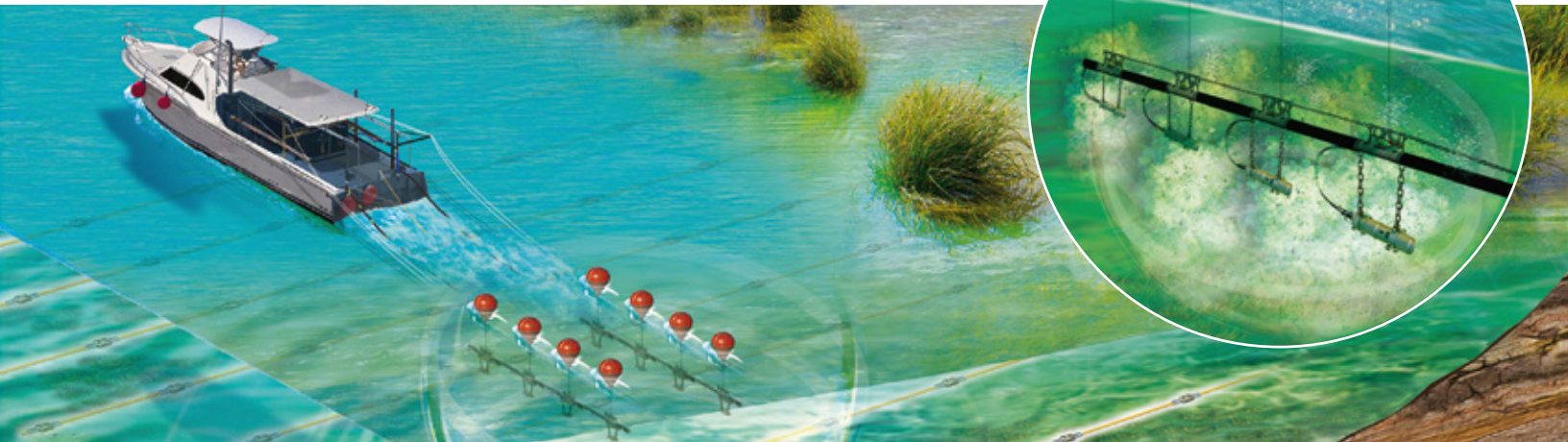

MINI G-SOURCE / MINI GI-SOURCE

Scaled-down models from the already compact GI and G-SOURCE are available for high-resolution, shallow water and transition zone surveys. The Mini G and Mini GI impulsive sources have the same advantages as their larger counterparts, but with even simpler technology.

Specifications



	Mini GI	Mini G 12	Mini G 20	Mini G 24	Mini G 40	Mini G 60
Volume	60cu.in (G = 30cu.in I = 30cu.in)	12cu.in	20cu.in	24cu.in	40cu.in	60cu.in
Length	L = 560mm	L = 390mm	L = 390mm	L = 390mm	L = 390mm	L = 390mm
Width	W = 200mm	W = 200mm	W = 200mm	W = 200mm	W = 200mm	W = 200mm
Weight	28.1kg	25.4kg	24.2kg	23.7kg	24.3kg	25.8kg

BOREHOLE

G-SOURCE FOR DELTA CLUSTER

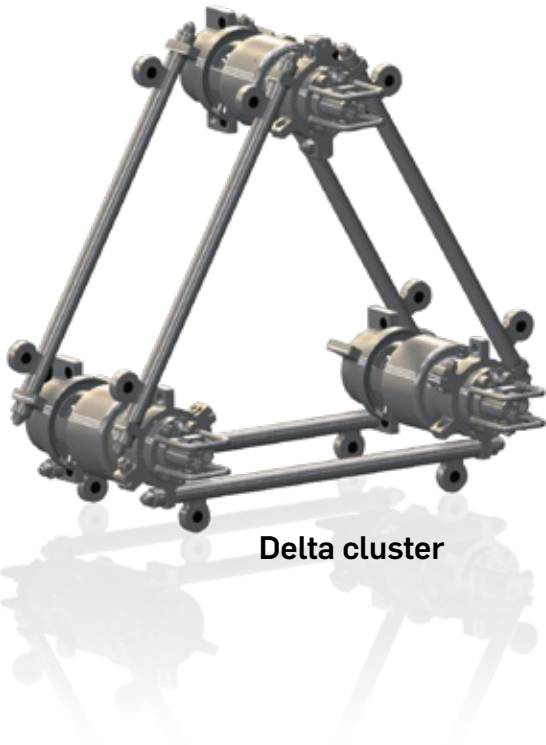

Delta cluster



Designed to operate continuously at up to 3,000 psi (210 bars)



Recoilless



VSP market standard

Over the years the Sercel G-SOURCE range of products has become the system of choice for advanced VSP surveys, in both offshore and onshore environments. The G-SOURCE and delta cluster combines the advantages of a powerful source and a clean acoustic performance to maximize borehole data quality.

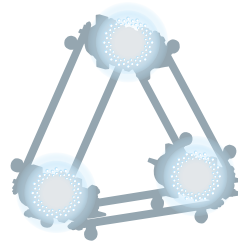

Phase 1

The Sercel delta cluster is an arrangement of three impulsive sources providing an improved signal characteristic.

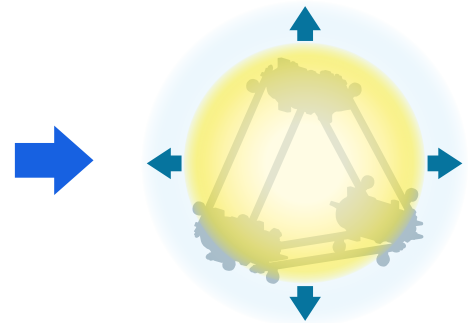

Phase 2

The delta-cluster arrangement provides more output and a higher peak-to-bubble ratio compared to a single impulsive source of an equivalent volume.

Specifications



	G-SOURCE 150	G-SOURCE 250
Volume	45 • 50 • 60 • 70 • 80 • 90 • 100 • 110 • 120 • 130 • 140 • 150	180 • 200 • 210 • 220 • 250
Length	L = 597mm	L = 597mm
Width	W = 292mm	W = 292mm
Weight	55kg	65kg

High-energy cluster configuration

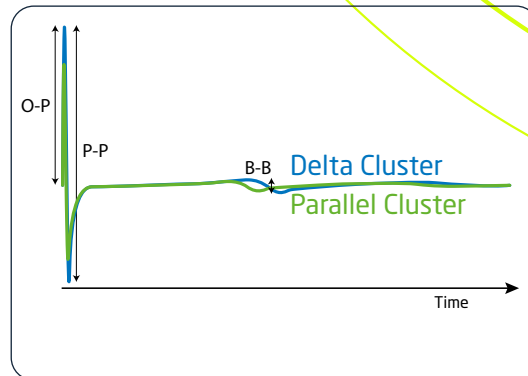
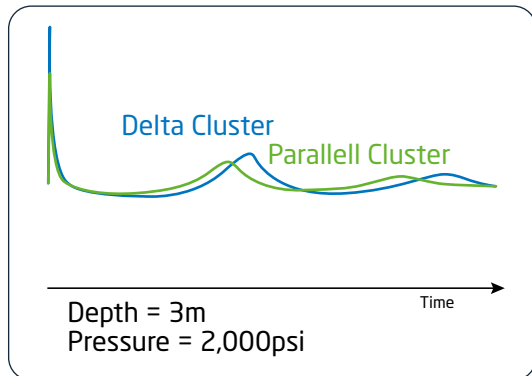

Near field signatures

The Delta Cluster & Parallel Cluster will produce a higher peak performance within a similar overall arrangement of a single impulsive source. The Delta cluster getting the edge over the Parallel by lowering the fundamental frequency.

Far field amplitude spectra

Sercel developed the Delta Cluster by adding a third impulsive source to the Parallel cluster assembly. It generates great output performance with unrivalled acoustic signature (+33 % in Peak-Output, + 19% in peak-to-bubble).

With an installed base of over 5000 units, the G-SOURCE has proven its efficiency and reliability in all environments. G-SOURCE is now the system of choice for the major players in the industry.

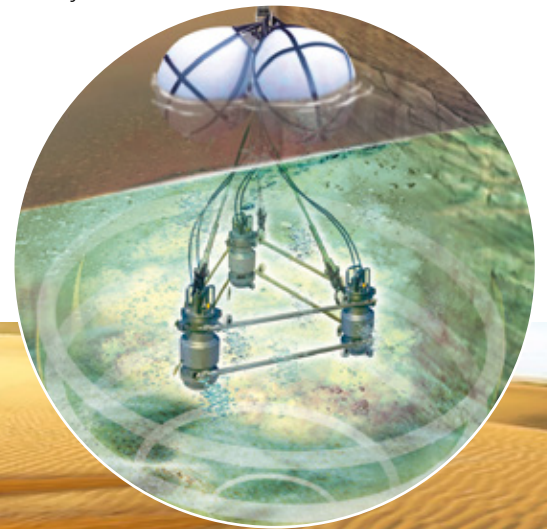

ACCESSORIES

IMPULSIVE SOURCES PLATES

Sercel provides heavy duty impulsive source plates that are compatible with all impulsive source synchronizers available on the market.

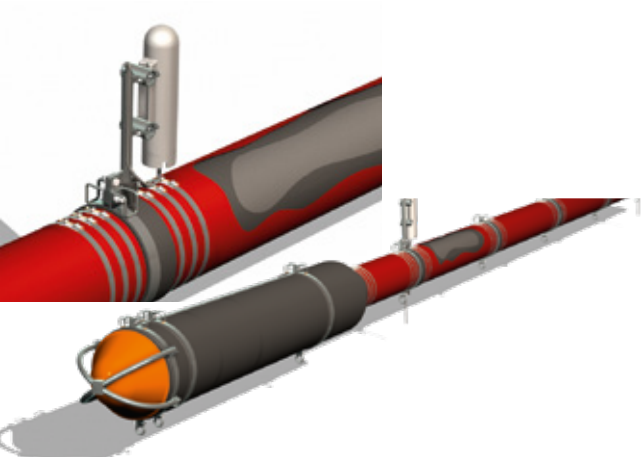

This flexible float is stable at sea due to its foam inserts & is safe as no inflation is required.

FLOATS

Operated by major geophysical service providers, Sercel has developed float technology for rigid and flexible Handling systems:

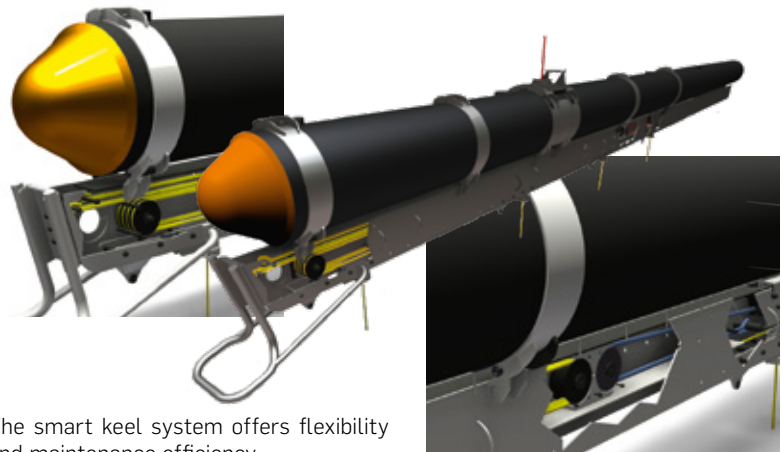

The smart keel system offers flexibility and maintenance efficiency.

IMPULSIVE SOURCE EQUIPMENT

For customers looking for a turnkey solution, Sercel is able to provide associated marine source peripherals such as terminated armoured umbilicals, slings, air swivels, back-deck cables, interface panels and impulsive source synchronizers ensuring full compatibility between all our equipment.

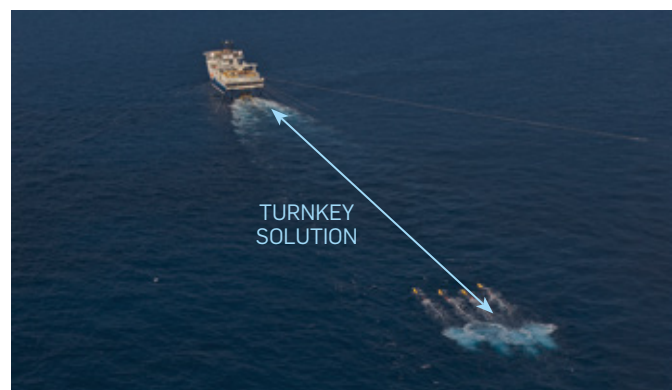

TURNKEY
SOLUTION

PORTABLE SOLUTIONS



Sercel is the exclusive distributor of the turn-key towing solutions designed by SeaScan Inc.

SeaScan Inc is the best partner for Sercel's turn-key solutions as the equipment is specifically designed for shallow water and transition zone areas.

The portable frames allow for quick mobilization and operations onboard multi-purpose vessels or barges.

TRI-CLUSTER®

Medium size array

The Tri-Cluster offers high power output thanks to its unique point source design.

The array includes 8 sources, combining concentrated parallel and square clusters for maximized acoustic performances.

The Tri-Cluster can be fitted with an optional cage protecting the sources in hazardous water, such as rivers with heavy debris.

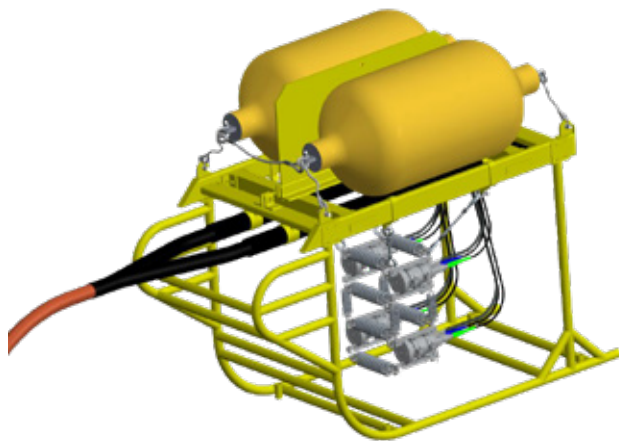
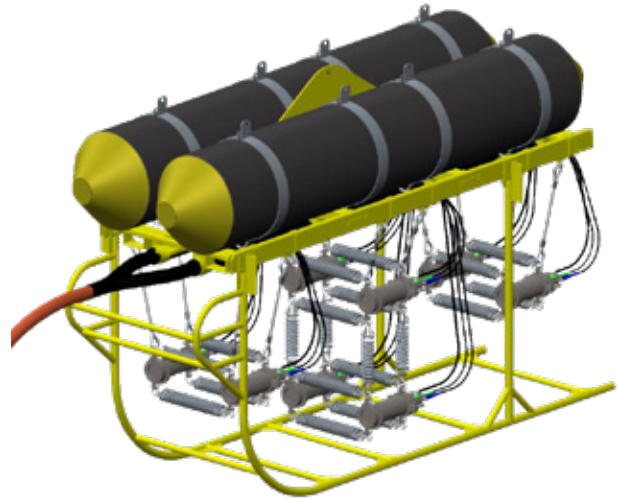

MINI SLED

High resolution array

The MINI SLED is designed for operating 4 MINI G-SOURCE for high-resolution surveys.

Light and compact, it benefits from the square cluster powerful output.

SHALLOW WATER HARNESS

Shallow water array

The USW systems are designed for small arrays or ultra-shallow water operations.

Two versions are available:

- single sources (up to 2 sources)
- parallel cluster sources (up to 4 sources)

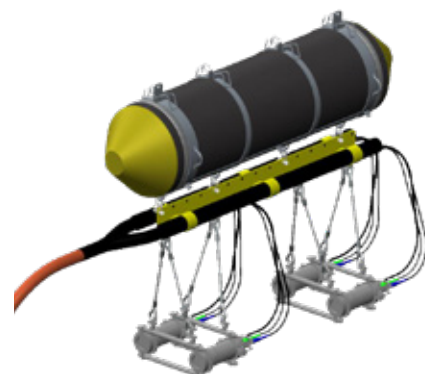

SERCEL - FRANCE

16 rue de Bel Air
B.P. 30439 - 44474 CARQUEFOU Cedex
Téléphone : (33) 2 40 30 11 81
E-mail : sales.nantes@sercel.com
SAS au capital de 25 000 000 €
Siège Social : 16 rue de Bel Air - 44470 CARQUEFOU
378.040.497 R.C.S. Nantes Code APE 2651B

SERCEL INC. - U.S.A.

17200 Park Row
Houston, Texas 77084
Telephone : (1) 281 492 6688
E-mail : sales.houston@sercel.com

www.sercel.com

© Sercel 06/24

Produced according to the Sercel environmental printing standard

